

MOLECOR

Orienting the future

**Complete solutions for the market
of water under pressure**

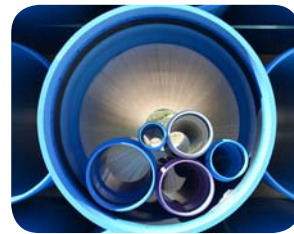
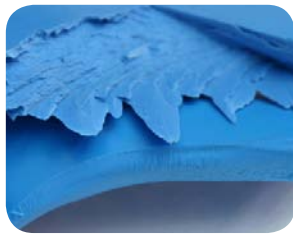
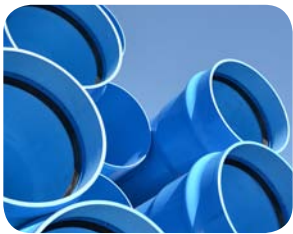

Molecor

Molecor is a Spanish leader company specialized in the development of the **Molecular Orientation technology** applied to canalizations of water under pressure.

It was founded in 2006 and since then, its exponential growth and continuous improvement in the development of efficient and innovative technology for the manufacture of Oriented PVC solutions, have made of the company the current world leader.

Our mission: Generating wealth in our environment making technology available to the market.

Our vision: Being a world leader in the development and application of technologies for the plastics processing industry.

Our values:

- Commitment to human capital (talent, effort and results)
- Equality opportunities
- Commitment to technological development
- Transparency, loyalty and trust
- Commitment to the environment

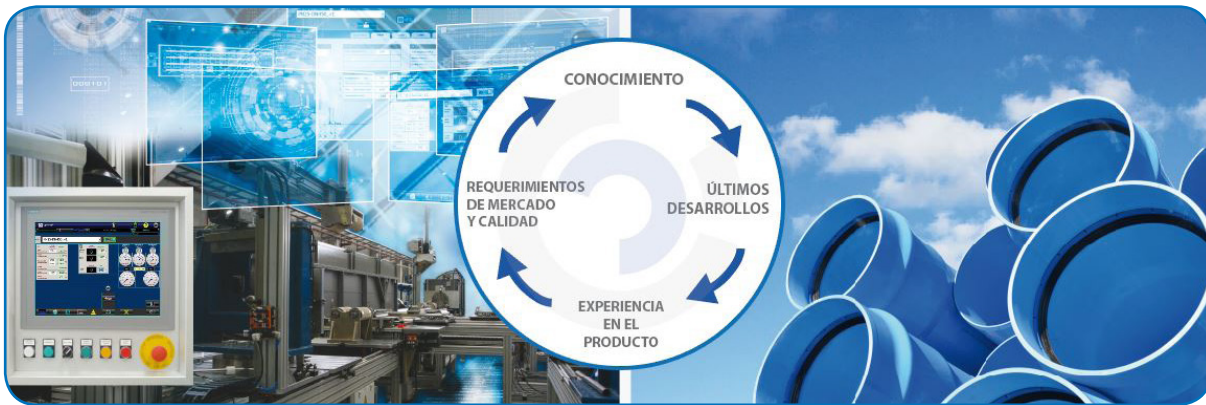

- **Molecor** establishment
- **Air Based System** development
• **PVC-O pipe**
• **DN200 mm**
- **M-OR-P 1640** technology development
• **DN90 y DN400 mm**
- **AENOR** Certificates (N mark) y **AFNOR** (NF mark)
• **M-OR-P 1640** implementation in **Australia**
- **M-OR-P 3163** technology development
• **M-OR-P 1640** implementation in **Italy**
• **DN500 mm PN25**
- **M-OR-P 1640** implementation in **Ecuador**
• **DN630 mm**

R & D and manufacturing machinery center



Getafe.

Molecor has two headquarters in the province of Madrid. In Getafe are the **facilities dedicated to R&D**, center in which new systems, increasingly efficient, for manufacturing products of PVC-O for the conveyance of water under pressure are developed.

The development of the technology for manufacturing PVC-O pipes up to DN1200 mm is one of the latest projects in which the company is working on, together with the development of the technology for manufacturing fittings of PVC-O.

PVC-O pipes Factory

In Loeches is located the **manufacturing center** with six production lines of TOM® PVC-O pipes. Facilities in which all the available diameters are produced, **from DN90 up to DN800 mm** in pressures **from 12,5 up to PN25 bar**. These products are manufactured with the technology developed in exclusive by the company and are exported to five continents. Thousands of kilometers of **TOM® PVC-O pipes** are already installed all over the world in supply networks, irrigation, reclaimed water, fire protection nets, etc.



Loeches.

- **Integrated Seal System (ISS+)** development
- **M-OR-P 3163** implementation in **Australia**
- **M-OR-P 1640** implementation in **Colombia**

- **M-OR-P 1640** implementation in **Ecuador**
- Production capacity: **11,000T/year**

- **M-OR-P 3180** technology development
- **AENOR** Certificate of Environment Management
- Production capacity: **14,000T/year**

- **M-OR-P 1640, M-OR-P 3163 and M-OR-P 3180** implementation in **India, Malaysia and Canada**
- **DN800 mm**
- Production capacity **20,000T/year**

- **M-OR-P 1640** implementation in **Kazakhstan**
- **Factory** opening in **South Africa**



2012



2013



2014



2015





2016

Molecor, solutions present all over the world

Since the beginning of its activity, Molecor had a clear **international vocation**, taking place its first technology sale in Australia. Molecor's internationalization mission refers to a solid and sustainable business model, leaning fundamentally on the **markets development**, bringing a product that offers unbeatable arguments for the conveyance of water under pressure in comparison with other alternatives. This market development it is achieved either supplying the product or the technology, and in the last years implementing **productive plants in foreign markets**.

Internationalisation is part of Molecor's DNA. Molecor was born as a result of an idea, an idea to manufacture PVC-O pipes in a more efficient way and to widen their range of application and functionalities. The mission with which this company started, which today remains, "*Generating wealth in our environment making technology available to the market*", shows the motivation to expand this technology in different markets around the world.



-  Molecor's technology presence
-  Molecor's TOM® pipes presence
-  Molecor's manufacturing plants

*The most advanced technology
at the service of water*

The firm commitment of Molecor to R&D goes beyond the development of the technology, recognized with several PCT registered all over the world in the OMPI. It has reflected its technical breakthroughs with the manufacturing and commercialization in the five continents, with new functionalities that optimize its behavior or progresses in the manufacturing process, improving the customer experience, adapting to the different demands of the market and with **innovations that widen the range of products** reaching applications previously reserved for other solutions.

Molecor shows these technical breakthroughs with the **manufacturing and commercialization of TOM® PVC-O Pipes in the five continents**. TOM® PVC-O pipes are available in a large range of **nominal pressures (12.5, 16, 20 and 25 bar)** and **nominal diameters (from 90 to DN800 mm)**. These pipes are more and more frequently used in the construction of water under pressure nets since they are the current most efficient solution for water management.



Molecor system. Overpassing the technological barriers

Molecor developed in 2007 an exclusive and genuine **Air Based System**, an evolved system that produces Oriented PVC pipes, tube to tube, working concurrently with the extrusion line of PVC ensuring thereby, the maximum quality of the product.

This system allows manufacturing PVC-O pipes using air instead of water throughout all the orientation process what result in a turning point against the existing systems up to this moment.

Molecor's Air Based System increases the speed, offers greater energy efficiency and removes the intermediate stock turning into a system that works in a continuous way, at the same rate than the conventional extrusion PVC lines.

The use of air instead of water provides the system a series of advantages against others manufacturing systems.

Security and reliability



Ductility and compatibility



Efficiency and productivity



Savings and profitability



Security and reliability

Dry system

- Clean system
- Use air instead of water
- No boiling water leakages
- Most secure system



Stability

- The Orientation takes place in a closed environment (mold)
- Continuous extrusion and orientation but disconnected to prevent the propagation of punctual failures



Automatic system and control

- Intuitive system
- Low learning curve
- 100% automatic technology
- Parameters load via receipt



Remote assistance

- Access from Molecor headquarters to the monitors with possible malfunctions
- Preventive remote assistance
- Quality control



Ductility and compatibility

- Structured development process for “customized solutions” under request.
- Quick diameter change. While the extruder works, adjustments may be applied in the Molecor technology and viceversa.
- Compatible with standard PVC extrusion systems.



Efficiency and productivity

The challenge achieved by Molecor is to develop an industrially feasible and effective technology compatible with conventional PVC pipes. Using this technology is easy, it has a low learning curve with which a special training is not required to start using it.

Security and quality

- Clean system that offers security to the operators against boiling water leakages thanks to the use of air.
- Quality control tube to tube.
- Remote access for trouble shooting production.
- Monitoring and advice on preventive maintenance.

Energy efficiency

- Energy applied only in the pipe by specific air distribution.
- Automatic, low labour required.
- Power consumption comparable to a conventional extrusion line.
- Reprocessed material use.

Production

- In-line work at the same speed as the extruder.
- No intermediate stocks.
- Fast and easy start in less than an hour.
- Standard factory distribution, even for large diameters.

The technology developed by Molecor meets the requirements of various international standards. What is more, those projects that do not comply with a listing of standards are supported during the certification and standardization processes when required.

Quality equipment: the product complies with safety, health and environmental requirements of the EU as well as with the placing the CE mark on the product



Molecor System. Technology to manufacture the largest PVC-O pipe in the world

Integrated Seal System (ISS+)

Automatic positioning of the gasket and form of the socket

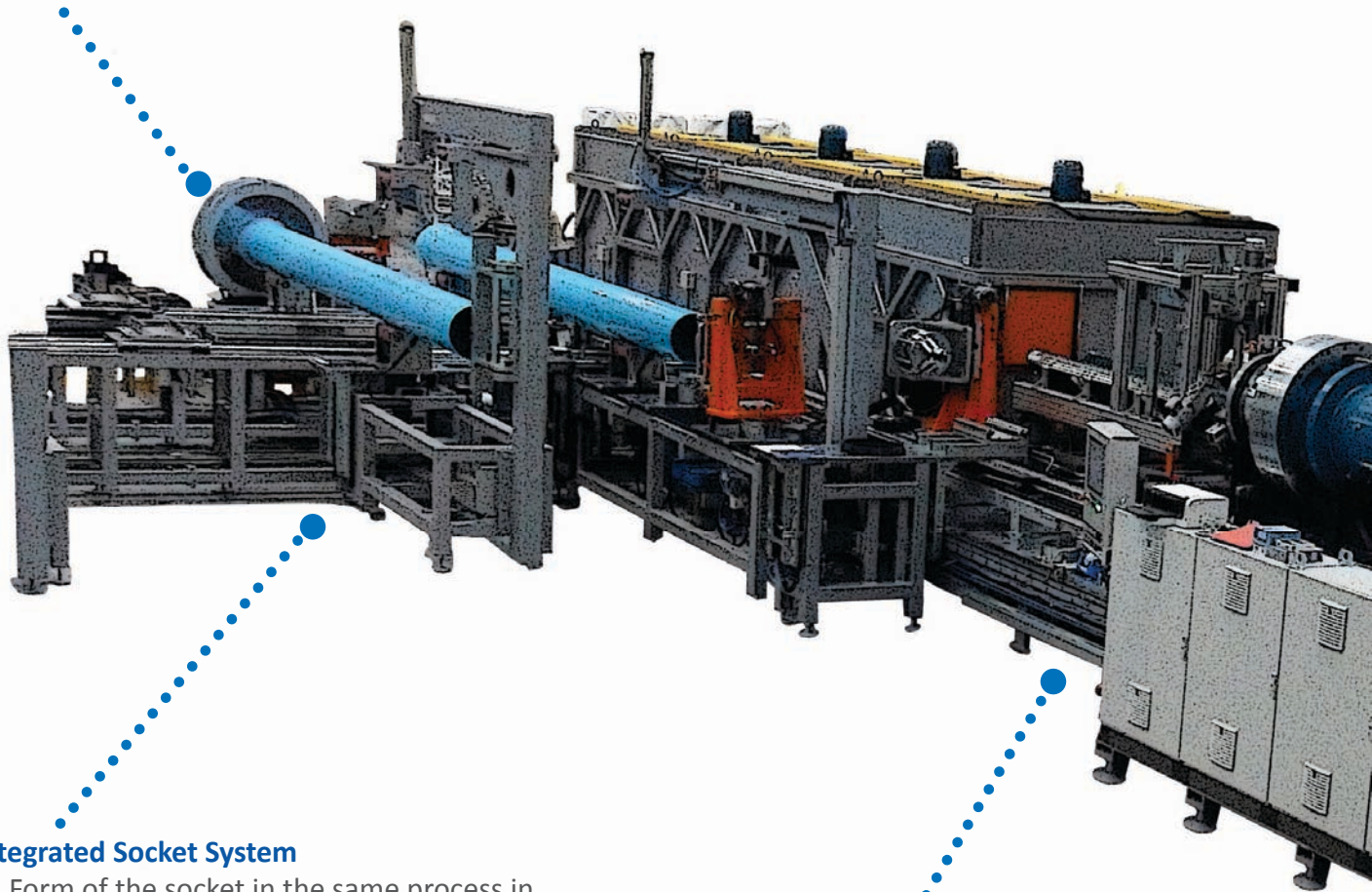

Integrated Socket System

Form of the socket in the same process in which orientation takes place

100% automatic System. Receipt System

Low learning curve

The widest range of products

From DN90 mm up to DN800 mm in nominal pressures up to 25 bar.

Genuine Air Based System

Efficiency, cleanliness, security, easy maintenance, etc.

The higher degree of orientation

Class 500 PVC-O pipes with the best mechanical properties and the maximum raw materials savings

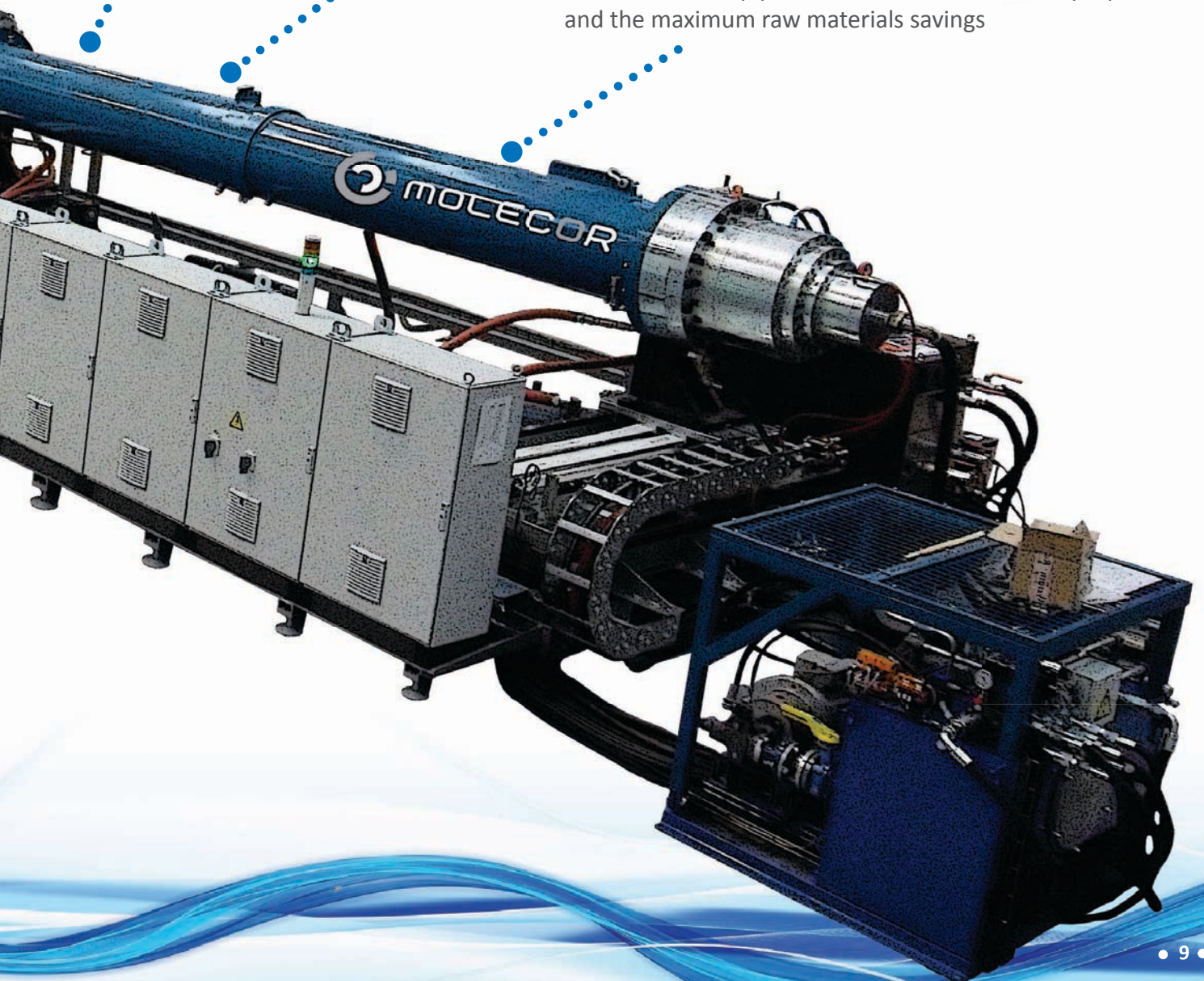
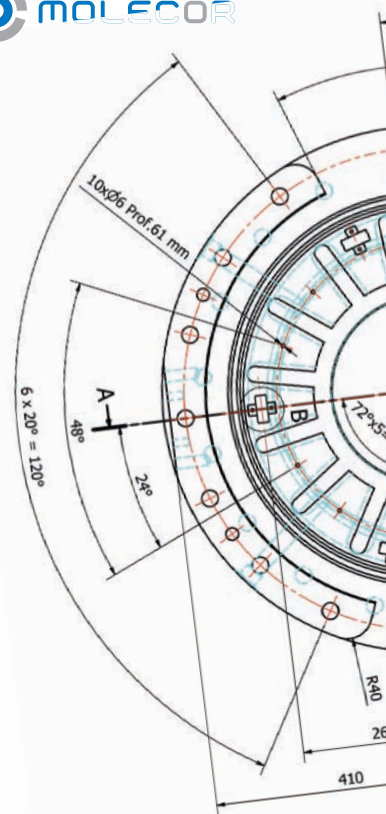

Why Molecor?

R&D. The heart of the company



R&D



Know-How



100%
specialization



Exclusive products

Molecor Tecnología is a company committed to innovation and development, with an apparent international vocation, which commercialize its products and technology developed entirely in Spain. **Molecor** bets firmly on **R&D**, issue in which it invests more than 5% budget billing. This bet goes beyond the development of the technology, recognized with several PCT registered OMPI all over the world with deals and the most valued public centers of Research and Development in Spain such as the Center for Technological and Industrial Development and the National Innovation Company.

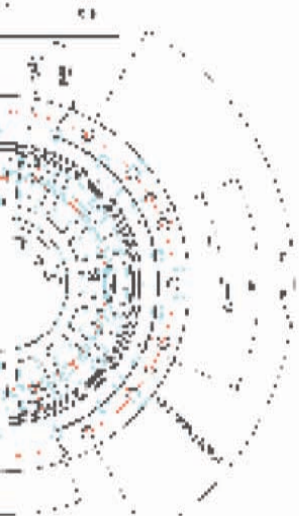

The company has reflected its technical breakthroughs with the manufacturing and commercialization in the five continents, with new functionalities that optimize its behavior or progresses in the manufacturing process, improving the customer experience, adapting to the different demands of the market and with innovations that widen the range of products reaching applications previously reserved for other solutions.

As a result of its R&D process, Molecor offers monitored projects to its clients providing them with new competitive strengths and strategic opportunities in the market of the conveyance of water under pressure.



Institutional recognition for
innovation



Constant growth and
development of new products



New solutions for PVC-O pipes

Know-how. Support in all the areas

Due to the company's effort in R&D and its exclusive dedication to PVC-O, Molecor has a complete knowledge of the sector, being able of providing support in all the phases of the manufacturing and installation processes of the product.

360° support:

- Certification and standardization
- Promotion and Sales
- On-line & off-line tools for support
- Complete support during installation
- Industrial support

*From DN90 up to DN800 mm
and from PN12,5 up to PN25*

Thanks to these knowledge and development, Molecor offers the widest range of PVC-O pipes in the market in a vast variety on nominal pressures.

Besides this, **TOM® pipes** provide the higher performance of the **installation in meters/hour** compared to other solutions, due to its **lightness**, **ductility** and its **easy connection**, mainly.

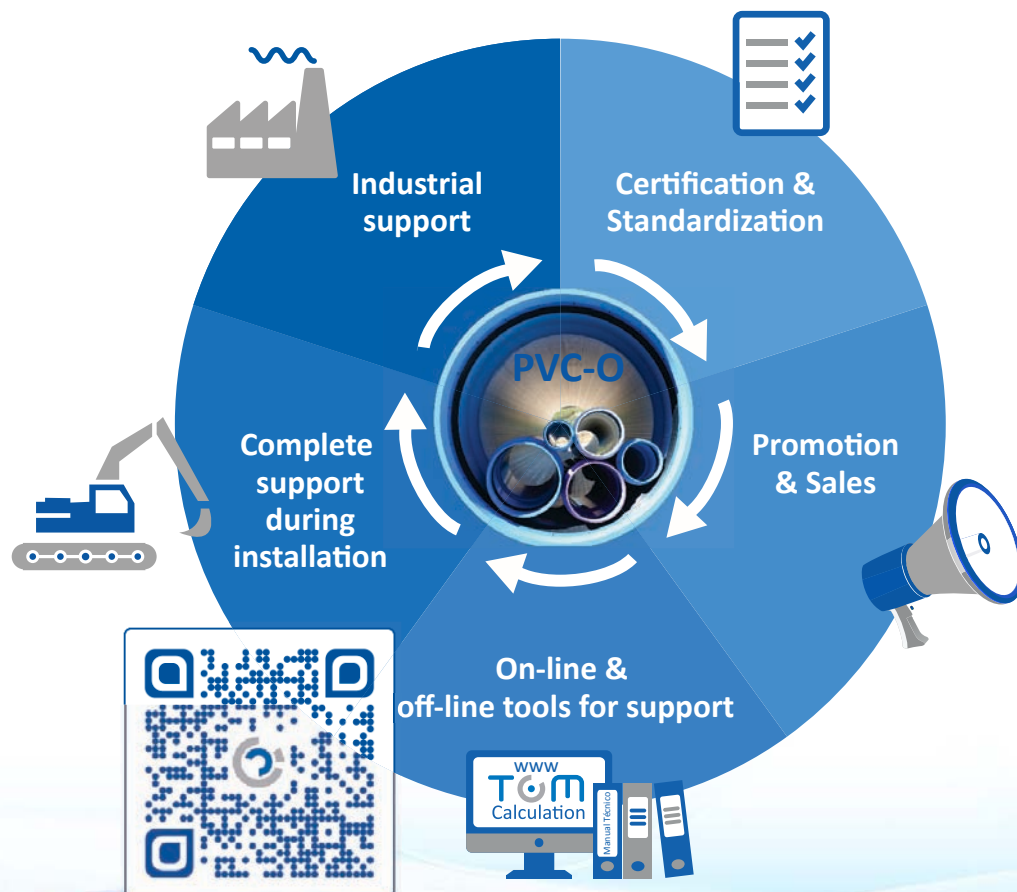

100% specialization. Exclusive dedication

Molecor is dedicated exclusively to the development of Molecular Orientation technology applied to PVC and to develop highly efficient solutions for the conveyance of water under pressure. The projects developed by Molecor have been recognized by several institutions and have won several awards that guarantee their quality and efficiency.

Throughout its trajectory, Molecor has received several awards and recognitions that have contributed significantly to consolidate its presence and global leadership as a company dedicated to the development of technology for the manufacture of Oriented PVC pipes. Among the most important awards received by Molecor they are:

Entrepreneur XXI Award

2012 was the year in which Molecor received this award, an award that recognises the most innovative companies of two to seven years, acknowledging the contributions made with profitable and sustainable solutions for society.



Solvin Awards 2013

In 2013 Molecor was awarded with the highest recognition in the SolVin Awards competition, dedicated to innovation and technological advances of PVC in different sectors.



CEPYME 2015 Award

Molecor was named best "Small Business of the Year" Awards 2015 in CEPYME II convening the Spanish Confederation of Small and Medium Enterprises with the Spanish Federation of Autonomous (CEAT); award received by Ignacio Muñoz, Director of the company, from the hands of His Majesty the King Felipe VI.



Exclusive products. Technology & Products globally unique

Molecor has developed a **Genuine Air-Based System** in which its technology is based. This technology enables the company to manufacture **PVC-O pipes of DN500, DN630 and DN800 mm** in diameter and up to **PN25 bar**; the latter being the larger diameter pipe made of this material worldwide.

Besides this, Molecor has developed the **Integrated Seal System ISS+**, a 100% automatic system which introduces a reinforced rubber gasket in the pipe just after the orientation process takes place, maintaining the excellent mechanical properties of the pipe especially in the socket.

PVC-O fittings are another innovation of Molecor. With these fittings the company will offer a completely innovative solution for pressurized water pipelines. Their absolute corrosion resistance, light weight and ease of installation, 100% recyclability or the overall quality of water transported are just some of the characteristics of the PVC-O pipes and fittings manufactured by Molecor.



TOM[®], PVC-O pipes installed all around the world

The projection of hydraulic networks is done globally and increasingly more usually, the material chosen for its implementation is the TOM[®] PVC-O pipe, thanks to the wide range of advantages for all parties involved in the sector, from the promoter to the end user.

In an effort to publicize the advantages of the product, Molecor works actively in promotional campaigns in countries where it is not yet known, to present it as a clear and advantageous alternative to materials currently used in building water networks.



Among the characteristics of the TOM[®] pipes we can include:

- **Unbeatable impact resistance.** The great impact resistance reduces breakage during installation or testing works, preventing the propagation of cracks.
- **High short and long term hydrostatic resistance.** TOM[®] pipes have an expected service life of over 100 years.
- **Excellent response to water hammers.** The celerity of these pipes is lower than in other pipes which minimizes water hammer and reduces the chance of breakage.
- **Higher hydraulic capacity.** TOM[®] pipes have a hydraulic capacity between 15% and 40% greater than pipes with similar outer diameters made of different materials.

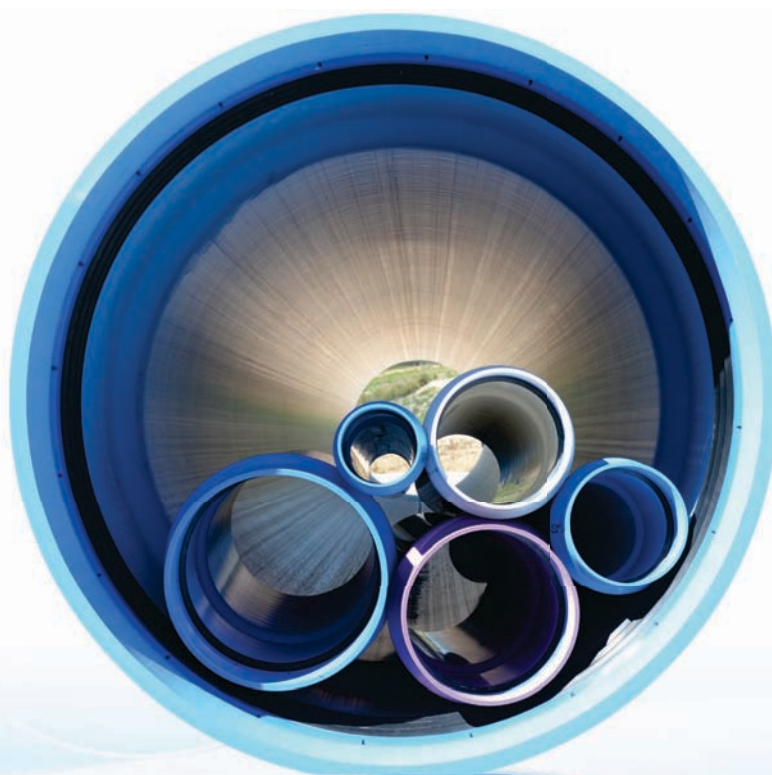



- **Maximum ductility.** These pipes have excellent elastic behavior which enables them to withstand large deformations of the inner diameter immediately recovering their original shape.
- **Completely corrosion-resistant.** PVC-O is immune to corrosion so that TOM® pipes are not degradable.
- **Total water quality.** The quality of fluid flowing through the TOM® pipes remains always unaltered since there is no corrosion of the material or migration.
- **Completely water-tight.** The pipe joints are completely sealed preventing the seal from moving during the installation.
- **Lightness and ease of installation.** The TOM® pipes are lighter and easier to install than pipes made of other materials.



TOM® PVC-O pipes
certified in 8 countries



The widest range of diameters
and pressures in the world



Progressive increase in the
manufacturing capacity of the
TOM® PVC-O pipes



Thousands of kilometers of
PVC-O pipes manufactured with
the Molecor technology



The most eco-friendly solution for water transportation

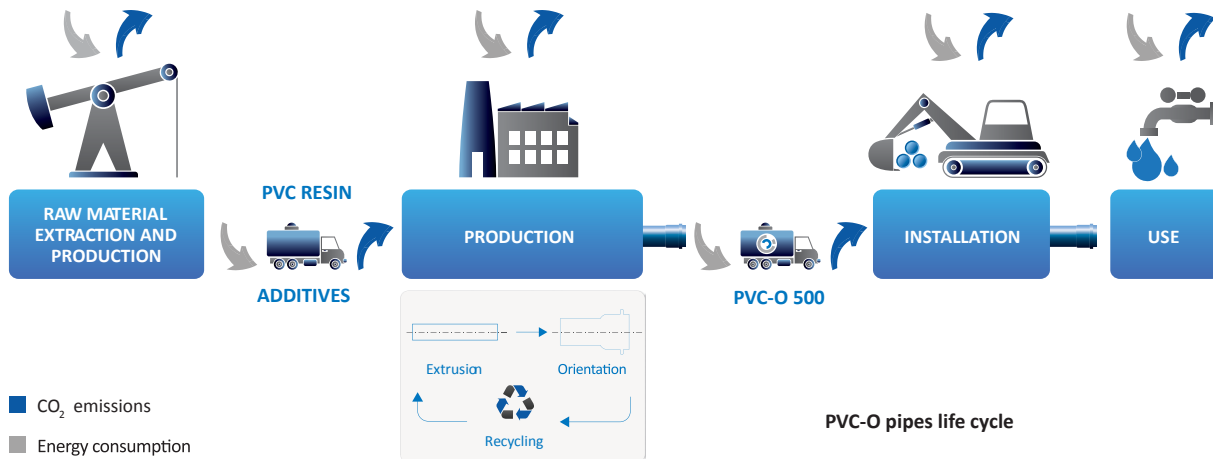

The environmental impact of a piping system depends on its composition and the application thereof, being the kind of material used, the manufacturing process, the high quality of the finished product and its useful life, the main factors that determine **the efficiency and sustainability throughout all its life cycle**.

Class 500 TOM® PVC-O Pipes are the most ecological solution in the market due to their better contribution to correct sustainable development of the planet, as it has been demonstrated by different worldwide studies. These pipes present **environmental advantages during their lifecycle**.

Efficiency in resources

Only 43% of the composition of PVC depends on oil. Moreover, thanks to the improved properties obtained during the Molecular Orientation, fewer raw materials are needed for manufacturing.

Energy consumption is lower in all phases of the life cycle: extraction of raw materials, manufacturing of pipe and use.

Pumping energy consumed in 50 years (kWh)

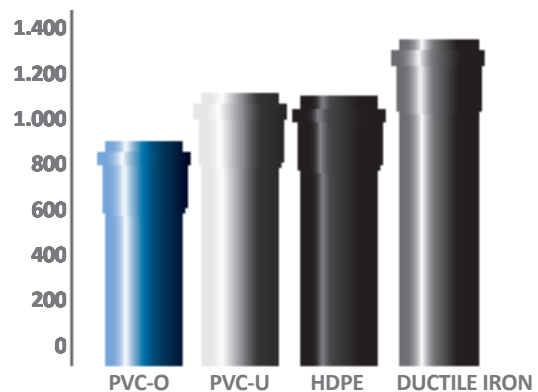

“ESTIMATION OF ENERGY CONSUMPTION AND CO₂ EMISSIONS DUE TO PRODUCTION, USAGE, AND FINAL USAGE OF PVC, HDPE, PP AND CAST IRON PIPES”. Department of Engineering Projects. Universitat Politècnica de Catalunya.

Efficiency in resource management

PVC-O 500 pipes are 100% recyclable. They can be ground and processed as rework material to be used in pipe production again or in the manufacturing of other plastic products, without losing any of their properties.



Sustainability

TOM[®] is a sustainable pipe in which design the environment preservation has been taken into account considering aspects as: energy saving, sustainable use of natural resources, constructions durability and respect to environment.

Always at the forefront, Molecor, following the last common methodology for calculating of the Recommendation 179/2013/EC proposed by the European Commission to study the Environmental Footprint of Product, has evaluated the environmental impact of the TOM[®] pipes in all the phases of its life cycle from cradle to grave, i.e. from extraction of raw materials to the final disposal of the product, through manufacture, distribution and use of the pipes.

| Environmental impacts | Absoluts | |
|---|----------|--------------------|
| Climate change* | 8.3E+01 | kg CO2e |
| Ozone depletion | 5.3E-06 | kg CFC-11e |
| Ecotoxicity – aquatic, fresh water | 1.8E+02 | CTUe |
| Human toxicity – cancer effects | 4.8E-06 | CTUe |
| Human toxicity - non-cancer effects | 8.6E-06 | CTUh |
| Particulate Matter / Respiratory Inorganics | 1.3E-02 | kg PM2.5e |
| Ionising radiation – human health effects | 5.3E+00 | kg U235e |
| Photochemical ozone formation | 4.1E-01 | kg NMVOC |
| Acidification | 4.1E-01 | mol H+e |
| Eutrophication - terrestrial | 1.0E+00 | mol Ne |
| Eutrophication – aquatic, fresh water | 1.6E-03 | kg Pe |
| Eutrophication – aquatic, sea water | 9.5E-02 | kg Ne |
| Resource depletion – water | 1.9E-01 | m ³ SWU |
| Resource depletion – mineral, fossil | 3.8E-03 | kg Sbe |
| Land transformation | 1.6E+02 | kg Cdef |

TOM[®] PVC-O Class 500 pipe's Environmental Footprint according to 179/2013/CE



The most ecological solution for the conveyance of water

According to this, the effect that TOM® pipes caused in 14 environmental impacts has been estimated.



Air and atmosphere

Climate change, acidification, depletion of the ozone layer and formation of photochemical ozone.



Water

Resource depletion (water), fresh water eco/toxicity and water eutrophication.



Soil

Resource depletion (minerals), land eutrophication and the use of the ground.



Human health

Respiratory inorganic elements, ionizing radiation, effects on human health (carcinogenics) and effects on the human health (no carcinogenics).

The Carbon Footprint is the best known environmental parameter. It takes into account the emission of greenhouse gases into the atmosphere which are known as CO₂ and are the responsible of the climate change. According to the environmental product declaration (EPD), **PVC-O pipes have a lower environmental impact**, not only in global warming, but also in other five environmental parameters.

TOM® pipes are provided with the Huella Ambiental FVS ecolabel, promoted by the “Fundación Vida Sostenible” and the Working and Social Safety Ministry’s company’s responsibility.



CO₂ emissions throughout the Lifecycle

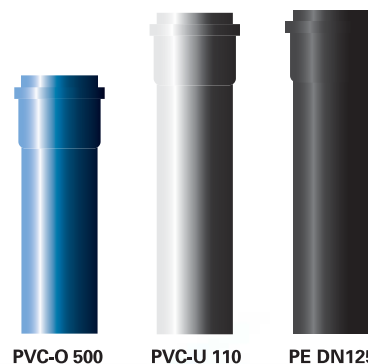

“ESTIMATION OF ENERGY CONSUMPTION AND CO₂ EMISSIONS DUE TO PRODUCTION, USAGE, AND FINAL USAGE OF PVC, HDPE, PP AND CAST IRON PIPES”. Department of Engineering Projects. Universitat Politècnica de Catalunya.

Notes

A series of horizontal dotted lines for writing notes, spanning the width of the page.



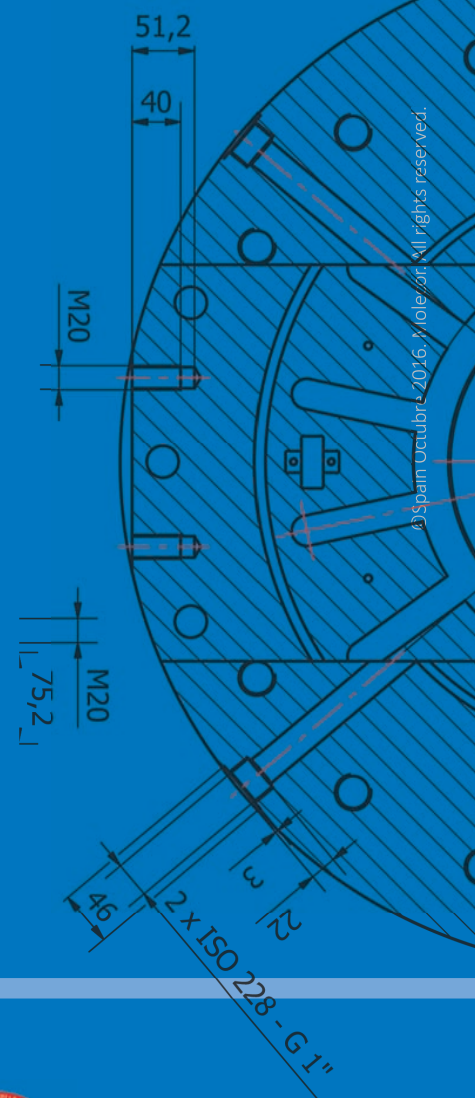

Supported by



R&D AND MACHINE MANUFACTURING CENTER

Parque Empresarial la Carpetania
C/ Cañada de los Molinos, 2
28906 Getafe - Madrid

Tlf: +34 911 337 090
Fax: +34 902 566 578
info@molecor.com

PVC-O PIPES MANUFACTURING CENTER

Carretera M-206, Torrejón a Loeches Km 3,1
28890 Loeches - Madrid

Tlf: +34 911 337 088
Fax: +34 902 106 273
canalizaciones@molecor.com

www.molecor.com

